

Novell Open Enterprise Server

www.novell.com

LAB GUIDE FOR OES LINUX

March 9, 2005

N

Novell®

Legal Notices

Novell, Inc. makes no representations or warranties with respect to the contents or use of this documentation, and specifically disclaims any express or implied warranties of merchantability or fitness for any particular purpose. Further, Novell, Inc. reserves the right to revise this publication and to make changes to its content, at any time, without obligation to notify any person or entity of such revisions or changes.

Further, Novell, Inc. makes no representations or warranties with respect to any software, and specifically disclaims any express or implied warranties of merchantability or fitness for any particular purpose. Further, Novell, Inc. reserves the right to make changes to any and all parts of Novell software, at any time, without any obligation to notify any person or entity of such changes.

You may not export or re-export this product in violation of any applicable laws or regulations including, without limitation, U.S. export regulations or the laws of the country in which you reside.

Copyright © 2005 Novell, Inc. All rights reserved. No part of this publication may be reproduced, photocopied, stored on a retrieval system, or transmitted without the express written consent of the publisher.

Novell, Inc. has intellectual property rights relating to technology embodied in the product that is described in this document. In particular, and without limitation, these intellectual property rights may include one or more of the U.S. patents listed at <http://www.novell.com/company/legal/patents/> and one or more additional patents or pending patent applications in the U.S. and in other countries.

Novell, Inc.
404 Wyman Street, Suite 500
Waltham, MA 02451
U.S.A.

www.novell.com

OES for Linux Lab Guide

March 9, 2005

Online Documentation: To access the online documentation for this and other Novell products, and to get updates, see www.novell.com/documentation.

Novell Trademarks

DirXML is a registered trademark of Novell, Inc. in the United States and other countries.

eDirectory is a trademark of Novell, Inc.

GroupWise is a registered trademark of Novell, Inc. in the United States and other countries.

NetMail is a trademark of Novell, Inc.

NetWare is a registered trademark of Novell, Inc. in the United States and other countries.

Novell Authorized Reseller is a service mark of Novell, Inc.

Novell is a registered trademark of Novell, Inc. in the United States and other countries.

Novell iFolder is a registered trademark of Novell, Inc. in the United States and other countries.

Novell NetStorage is a trademark of Novell, Inc.

Nterprise is a trademark of Novell, Inc.

Red Carpet is a trademark of Novell, Inc.

Third-Party Trademarks

All third-party trademarks are the property of their respective owners.

This product includes materials licensed under the Apache license, including, Apache and Tomcat.

This product includes code licensed from RSA Security, Inc. Some portions licensed from IBM are available at <http://oss.software.ibm.com/icu4j/>.

Contents

- About This Guide** **7**

- 1 Installing an OES Linux Server in Your Lab** **9**
 - Have the Required Lab Setup 9
 - Create or Obtain Installation Media. 10
 - Install the Server Software 11
 - Prerequisites 11
 - Procedure 12
 - Configure the SLES 9 Server. 13
 - Configure eDirectory 14
 - Configure OES Services 15
 - Check the Hardware Configuration. 16
 - What's Next. 16

- 2 eDirectory and Identity Services** **17**
 - Using the eDirectory Information in This Guide. 17
 - An Introduction to eDirectory Planning 18
 - Your Lab's eDirectory Tree 18
 - Your Current Lab Tree 19
 - Expanding Your Lab Tree. 20
 - Access iManager 21
 - Create a Context for Your Users and Groups 22
 - Set Up Universal Password for Users 23
 - Create and Enable a Group Object for Linux User Management (LUM) 23
 - Create Users (First Server in the Tree). 24
 - LUM-Enable Existing Users (First OES Linux Server in the Tree) 25
 - A Note about Identity Manager Bundle Edition 25
 - What's Next. 26

- 3 Novell Samba (Windows File Services) on OES** **27**
 - Overview of Novell Samba 27
 - Create Samba User Home Directories 28
 - What's Next. 29

- 4 Novell iFolder** **31**
 - Overview of iFolder 31
 - Set Up User Search Contexts 32
 - Enable iFolder Users 33
 - What's Next. 33

- 5 Virtual Office** **35**
 - Overview of Virtual Office. 35
 - What's Next. 36

- 6 iPrint** **37**
 - Overview of iPrint. 37

Create an eDirectory Context for Printers	38
Create a Print Driver Store	39
Add Printer Drivers to the Driver Store from the Windows Platforms	39
Create a Print Manager Object	40
Create iPrint Printer Objects.	40
What's Next	41
7 NetStorage	43
Overview of NetStorage	43
What's Next	44
8 eGuide	45
Overview of eGuide	45
What's Next	46
9 Linux User Management	47
Overview of Linux User Management	47
What's New	48
10 Getting Acquainted with OES	49
Using Samba (Windows File Services)	49
Using iFolder	50
Access User Accounts Using the iFolder Client	50
Observing File Synchronization	51
Using Virtual Office	51
Using iPrint	51
Using NetStorage	52
Using eGuide	52
Using Linux User Management (LUM)	52
What's Next	53

About This Guide

Most organizations test new products in a lab setting prior to making them available for general use.

This guide is designed to help you set up a Novell® Open Enterprise Server (OES) server in a lab environment using a specific and simplified configuration. The configuration is limited in scope and is meant only to acquaint you with OES and provide exposure to the Novell products it contains.

Guide Purposes

The instructions in this guide will help you do the following:

- ◆ Install an OES Linux* server into an eDirectory™ tree named EXAMPLE_TREE.
If you already installed OES for NetWare® using the instructions in the *OES for NetWare Lab Guide*, you will install this server into the tree you created during that installation.
- ◆ Install select OES components on the server.
- ◆ Perform simple tasks to get acquainted with basic OES services.

About Information Flow in This Guide

The sections in this guide are designed to be accessed sequentially, and they guide you through the following main tasks:

1. Installing an OES Linux server.
2. Setting up the eDirectory infrastructure—user objects, group objects, passwords, etc.
3. Reviewing the services featured in the guide and performing all additional setup tasks required for test driving and exploring the features.
4. Test driving and exploring the features.

Using This Guide as a Reference

If you want to install additional OES servers or create a different tree structure than the one specified in this guide, you can still use these instructions as a basic guide for setting up OES services in a lab environment. However, you will probably also want to refer to the information found in the following guides:

- ◆ *Novell OES Planning and Implementation Guide*
- ◆ *OES for Linux Installation Guide*

Documentation Conventions

In this documentation, a greater-than symbol (>) is used to separate actions within a step and items within a cross-reference path.

A trademark symbol (® , ™, etc.) denotes a Novell trademark. An asterisk (*) denotes a third-party trademark.

When a single pathname can be written with a backslash for some platforms, or a forward slash for other platforms, the pathname is presented with a forward slash to reflect the Linux convention. Users of platforms that require a backslash, such as NetWare, should use backslashes as required by the software.

1

Installing an OES Linux Server in Your Lab

WARNING: When you create a new eDirectory tree that will contain both NetWare® and Linux* servers you must start the Tree creation using a NetWare server first.

If you use a Linux server to create a new Tree and subsequently add a NetWare server to this newly created tree, you will not be able to install any Client or Server Licenses. Any features that require either a NetWare Server license and/or NetWare Client Access license will be inaccessible.

Novell will be addressing this problem in a subsequent release of Open Enterprise Server.

Use the instructions in this section to install Novell® Open Enterprise Server (OES) in your lab.

This section describes the following tasks:

- ◆ [“Have the Required Lab Setup” on page 9](#)
- ◆ [“Create or Obtain Installation Media” on page 10](#)
- ◆ [“Install the Server Software” on page 11](#)
- ◆ [“Configure the SLES 9 Server” on page 13](#)
- ◆ [“Configure eDirectory” on page 14](#)
- ◆ [“Configure OES Services” on page 15](#)
- ◆ [“Check the Hardware Configuration” on page 16](#)
- ◆ [“What’s Next” on page 16](#)

Have the Required Lab Setup

For the tasks and exercises described in this guide, you will need the following:

- A Server-Class Computer** with the following:

Component	Minimum	Recommended
Processor	Pentium* II or AMD* K7 450 MHz	Pentium III, Pentium III Xeon*, Pentium 4, or Intel* Xeon 700 MHz or higher
RAM	512 MB	1 GB
Display Adapter	Super VGA	VESA 1.2-compliant, high resolution
CD Drive	Supports the ElTorito Specification	

Component	Minimum	Recommended
Hard Drive	20 GB	
(All data will be erased)		
Network Card	Ethernet 100 Mbps	
IP Addresses	<ul style="list-style-type: none"> ◆ Two IP Addresses on lab subnet 	
(Novell iFolder [®] requires a separate IP address on Linux.)	<ul style="list-style-type: none"> ◆ Subnet mask ◆ Default gateway 	
Mouse	Not required	USB or PS/2

A Network Printer with an assigned static IP address and a connection to your lab network.

A Workstation with

- ◆ One of the following platforms installed:

- ◆ Windows XP
- ◆ Windows 2000
- ◆ Windows NT* 4

or

- ◆ Windows 95/98/ME

- ◆ Internet Explorer 6 SP1 or later installed.

We recommend you use IE for all instructions in this guide. Some procedures, such as iPrint installation, only work in IE.

- ◆ A print driver for the network printer installed on the workstation.

Create or Obtain Installation Media

As with many Linux products, Novell Open Enterprise Server (OES) is available on the Web.

You can also install Novell Open Enterprise Server using files or CDs obtained from your [Novell Authorized Reseller \(http://www.novell.com/partnerlocator\)](http://www.novell.com/partnerlocator). If you already have CDs from your reseller, skip to **“Install the Server Software” on page 11**.

To install Novell Open Enterprise Server using files from your reseller or the Novell Download Web site, you will need the following:

- A CD-R device on your workstation
- CD-burning software, such as Roxio Easy CD Creator or Nero, that is capable of creating CDs from ISO image files
- One 700 MB CD-R Media for each CD you need to create (six total)

You can obtain the CD image files by doing the following:

- 1** Register for a Novell Login account on the [Web \(https://secure-www.novell.com/selfreg/jsp/createAccount.jsp\)](https://secure-www.novell.com/selfreg/jsp/createAccount.jsp).

- 2 Access the [Downloads page for OES \(http://download.novell.com\)](http://download.novell.com) using your account.
- 3 Follow the [download instructions on the Web \(http://download.novell.com\)](http://download.novell.com) to ensure you download the image files you will need for these exercises and also to install OES for Linux in a production environment.

For the exercises in this guide, you will need the following CD image files:

- ♦ oes-linux-1.iso
- ♦ oes-linux-2.iso
- ♦ oes-linux-4-sles9-2.iso
- ♦ oes-linux-5-sles9-3.iso
- ♦ oes-linux-6-sles9-4.iso

As explained in the download instructions, if you already have a set of SLES 9 disks, you do not need to download their associated image files.

- 4 Verify the integrity of each .iso file by running an MD5-based checksum utility on it.

For example, on a Linux system you can enter the following command:

```
md5sum filename
```

where *filename* is the name of the .iso file you are verifying.

On a Windows system you will need to obtain a Windows-compatible MD5-based checksum utility from the Web and follow the usage instructions for the utility.

Checksum values for each file are listed in the [download instructions on the Web \(http://download.novell.com\)](http://download.novell.com).

- 5 Create the CDs that are required for the exercises in this guide using your CD-burning software and label each CD.

The following table shows the filenames and labels required for the exercises in this guide.

ISO Image Filename	Label
oes-linux-1-install.iso	Open Enterprise Server CD1
oes-linux-2.iso	Open Enterprise Server CD2
oes-linux-4-sles9-2.iso	SUSE LINUX Enterprise Server 9 CD2
oes-linux-5-sles9-3.iso	SUSE LINUX Enterprise Server 9 CD3
oes-linux-6-sles9-4.iso	SUSE LINUX Enterprise Server 9 CD4

Continue with [“Install the Server Software” on page 11](#).

Install the Server Software

Prerequisites

Before installing Novell Open Enterprise Server (OES) on your Linux server, you must have completed the following tasks:

- ❑ Ensure that the Linux server on which you are installing OES meets the requirements outlined in [“Have the Required Lab Setup” on page 9](#).
- ❑ Prepare the software for installation as explained in [“Create or Obtain Installation Media” on page 10](#).

Procedure

WARNING: This procedure will permanently erase any data currently on your server’s hard drive.

- 1** Prepare the BIOS on your server machine so that it will boot from the CD-ROM drive first.
- 2** Insert the CD labeled *Open Enterprise Server CD 1* into your server and reboot the machine.
- 3** After a few seconds, a boot selection screen appears. Immediately press the Down-Arrow to select the Installation option and press Enter.

If you don’t respond before the machine starts booting from the hard disk, you will need to reboot and start over.

- 4** Read and then agree to the Novell OES software license agreement.
- 5** Select and accept an installation language.
- 6** On the Installation Settings screen, scroll down the list and click Partitioning.
- 7** The OES install tries to add SLES 9 partitions to your existing partitions.

To ensure a clean install, use the following table to navigate and configure the partitioning screens.

Screen Name	Action
Suggested Partitioning	<ol style="list-style-type: none"> 1. Select Base Partition Setup on This Proposal. 2. Click Next.
Expert Partitioner	<ol style="list-style-type: none"> 1. Click Delete > Yes. 2. Click Create > OK.
Create a Primary Partition	<ol style="list-style-type: none"> 1. Click the File System drop-down list and select Swap. 2. In the End field type a partition size roughly twice the amount of RAM installed on the server. For example, if the server has 512 MB RAM installed, type 1024M. 3. Click OK.
Expert Partitioner	<ol style="list-style-type: none"> 1. Click Create > OK.
Create a Primary Partition	<ol style="list-style-type: none"> 1. Click OK.
Expert Partitioner	<ol style="list-style-type: none"> 1. Click Next.

- 8** At the Installation Settings screen, scroll down and click Software.

Use the following table to navigate and configure the software screens.

Screen Name	Action
Software Selection	1. Click Detailed Selection . . .
Selection list	1. Check iFolder 2.x. 2. Uncheck the following since they will not be used for the exercises in this guide: - Novell QuickFinder™ - Novell NCP™ Server - Novell Backup Services (SMS) - Novell Health Monitoring 3. Click Accept.
Automatic Changes	1. Click Continue.

9 At the Installation Settings screen, scroll down and click Timezone.

10 Select and accept your time zone.

11 At the Installation Settings screen, click Accept.

12 Click Yes, Install.

During the install, you must insert the following CDs when prompted and click OK after each insertion.

- ♦ Open Enterprise Server CD2
- ♦ SUSE LINUX Enterprise Server 9 CD2
- ♦ SUSE LINUX Enterprise Server 9 CD3
- ♦ SUSE LINUX Enterprise Server 9 CD4

After the files are copied, the system configuration takes a few minutes to complete.

Configure the SLES 9 Server

After the initial system configuration, the installation needs more information about the root user and the network.

Use the following table to navigate and configure the various configuration screens.

Screen Name	Action
Password for root	1. Enter and confirm the root user password.
Network Configuration	1. Click the Network Interfaces link.
Network Cards Configuration	1. Click Configure.

Screen Name	Action
Network Address Setup	<ol style="list-style-type: none"> 1. In the IP Address field, type the IP address you want to use for the server and all OES services except iFolder (which requires its own address). 2. Change the Subnet Mask if needed. 3. Click Host Name and Name Server.
Host Name and Name Server Configuration	<ol style="list-style-type: none"> 1. In the Host Name field, type the DNS hostname for the IP address you just assigned. 2. In the Domain Name field, type the DNS Domain Name for your network. 3. Type the IP address of at least one Name Server and type your DNS Domain Name in at least one of the Domain Search fields. 4. Click OK.
Network Address Setup	<ol style="list-style-type: none"> 1. Click Routing.
Routing Configuration	<ol style="list-style-type: none"> 1. Type the IP address of the default gateway for your lab subnet. 2. Click OK.
Network Cards Configuration	<ol style="list-style-type: none"> 1. Click Finish.
Network Configuration	<ol style="list-style-type: none"> 1. Click Next.
Test Internet Connection	<p>In a production environment it is critical that you have an Internet connection available to the server for software updates.</p> <ol style="list-style-type: none"> 1. If you have an Internet connection, click Next. Otherwise, skip to the Service Configuration screen.
Running Internet Connection Test	<ol style="list-style-type: none"> 1. The test should report success. Click Next.
Online Updates Available	<ol style="list-style-type: none"> 1. There should be online updates available. Click OK.
Welcome to YaST Online Update	<ol style="list-style-type: none"> 1. Click Next.
YOU Patches	<ol style="list-style-type: none"> 1. Select all the patches, then click Accept.
Patch Download and Configuration	<ol style="list-style-type: none"> 1. Click Finish.
Service Configuration	<ol style="list-style-type: none"> 1. Click Next.
OES Configuration - Now or Later	<ol style="list-style-type: none"> 1. Click Next (Configure Now).

Configure eDirectory

For the exercises in this guide, you need the eDirectory™, NTP, and SLP configurations outlined in the following table.

Screen Name	Action
eDirectory Configuration - New Tree	<ol style="list-style-type: none"> 1. In the Tree Name field, type EXAMPLE_TREE 2. Click Next
eDirectory Configuration - New Tree Information	<ol style="list-style-type: none"> 1. In the FDN Admin Name with Context field, type CN=admin.O=COMPANY 2. In the Admin Password and Verify Admin Password fields, enter the same password for the eDirectory Admin user. 3. Click Next. 4. Change the Server Context to OU=SERVERS.OU=LAB.O=COMPANY 5. Click Next.
eDirectory Configuration - NTP and SLP	<ol style="list-style-type: none"> 1. Time synchronization is required for eDirectory. If you have already installed the OES NetWare server (LAB_NW), type the NetWare server's IP address in the Network Time Protocol (NTP) Server field. Otherwise, assuming this is the first server in the tree, leave the field set to Local Clock. This will cause this server to be set up as an NTPv3 time source. 2. Click Next.
SLP Configuration	<ol style="list-style-type: none"> 1. Click Yes (don't configure SLP).

Configure OES Services

For the exercises in this guide, you need the specific service configurations outlined in the following table.

Screen Name	Action
Installation Settings	<ol style="list-style-type: none"> 1. Scroll down and click Novell Samba.
Novell Samba LDAP Server Configuration	<ol style="list-style-type: none"> 1. Click Next.
Novell Samba Configuration	<ol style="list-style-type: none"> 1. In the Base Context for Samba Users field, change the context to O=COMPANY 2. Click Next.
iFolder 2.x Configuration	<ol style="list-style-type: none"> 1. Click Next.
Installation Settings	<ol style="list-style-type: none"> 1. Scroll down and click iFolder 2.x.
iFolder 2.x LDAP Server Configuration	<ol style="list-style-type: none"> 1. Click Next.

Screen Name	Action
iFolder 2.x Web Configuration	<ol style="list-style-type: none"> 1. In the IP Address field, type the second IP address you identified during the planning process. 2. In the Netmask field, type the lab subnet mask. 3. In the DNS Hostname field, type the DNS hostname associated with the IP address entered in Step 1. 4. Click Next.
iFolder 2.x Configuration	<ol style="list-style-type: none"> 1. Click Next.
Installation Settings	<ol style="list-style-type: none"> 1. Click Next. As indicated on the screen, the iManager Plug-in configuration process can take several minutes.
Release Notes	<ol style="list-style-type: none"> 1. Click Next.

Check the Hardware Configuration

Although most Linux servers don't have a graphical user interface loaded, the lab server you are installing has the KDE interface loaded by default.

When the Hardware Configuration screen appears, check the Graphics Cards configuration to make sure your monitor was detected and that your color and resolution settings are the way you want them.

If the configuration is incomplete or wrong, click the Graphic Cards link and follow the on-screen prompts until your monitor and display settings (color, resolution, etc.) are correctly set up.

When the Graphics Card settings are correct, click Next.

When the Installation Completed screen appears, click Finish.

What's Next

After the server reboots, you can log in if you want to, but that isn't required at this time.

In the login splash screen, notice that the eDirectory Admin user is listed as an available user account. This is because of an integration of eDirectory with the local Linux user management system (POSIX). More about this in the next section.

Continue with [Chapter 2, "eDirectory and Identity Services," on page 17](#).

2

eDirectory and Identity Services

Novell® eDirectory™ is the central, key component of Novell Open Enterprise Server (OES) and provides the following:

- ♦ Centralized identity management
- ♦ The underlying infrastructure for managing your network servers and the services they provide
- ♦ Access security both within the firewall and from the Web

The installation scenario presented in this guide creates a new eDirectory tree named *EXAMPLE_TREE* that you can use for testing and learning about OES. As you work with the tree and the objects it contains, you will begin to better understand the role eDirectory plays.

This section discusses the following:

- ♦ [“Using the eDirectory Information in This Guide” on page 17](#)
- ♦ [“An Introduction to eDirectory Planning” on page 18](#)
- ♦ [“Access iManager” on page 21](#)
- ♦ [“Create a Context for Your Users and Groups” on page 22](#)
- ♦ [“Set Up Universal Password for Users” on page 23](#)
- ♦ [“Create and Enable a Group Object for Linux User Management \(LUM\)” on page 23](#)
- ♦ [“Create Users \(First Server in the Tree\)” on page 24](#)
- ♦ [“LUM-Enable Existing Users \(First OES Linux Server in the Tree\)” on page 25](#)
- ♦ [“A Note about Identity Manager Bundle Edition” on page 25](#)
- ♦ [“What’s Next” on page 26](#)

Using the eDirectory Information in This Guide

Before you install OES in a production environment, it is critical that you and your organization take time to plan and design your tree.

However, the instructions in this guide require no planning on your part. In fact, some of the eDirectory objects used in this guide were created in [Chapter 1, “Installing an OES Linux Server in Your Lab,” on page 9](#).

The information that follows introduces eDirectory.

If you are already familiar with eDirectory and want to skip the planning introduction, we recommend that you

1. View the eDirectory tree structure used in this guide ([Figure 1 on page 19](#)).

2. Then skip to “[Create a Context for Your Users and Groups](#)” on page 22.

An Introduction to eDirectory Planning

If you want an efficient and intuitive eDirectory design, you and your organization will need to base it on

- ◆ The layout of your network.
- ◆ The structure of your organization.

You and your team should carefully think through the issues and design considerations discussed in “[Designing Your Novell eDirectory Network](#)” in the *Novell eDirectory 8.7.3 Administration Guide*.

Your Lab’s eDirectory Tree

Figure 1 illustrates an eDirectory tree like the one you will use in the lab exercises found in this guide. It also illustrates and explains the basic elements you should consider when designing an eDirectory tree.

NOTE: The IS Organizational Unit object is included for explanation purposes and is not created in this guide.

Figure 1 Your Lab's eDirectory Tree

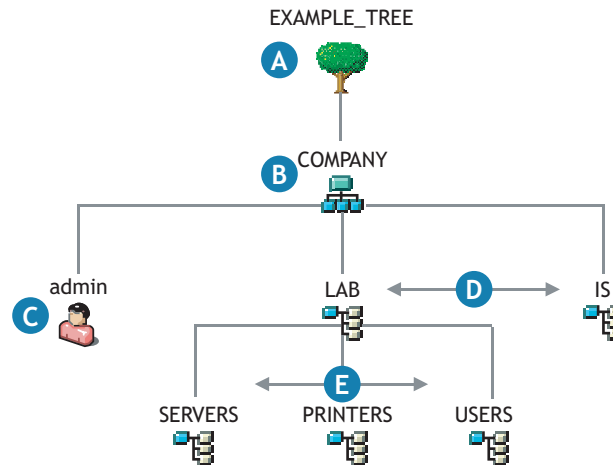

This illustrates the basic elements you should consider when planning your tree.

A The Tree object is the top container object in the tree. It usually contains an Organization object (specified in the install using O=COMPANY) that represents your company or organization.

B The Organization object is normally the first (and often the only) container object under the Tree object. It is typically named after your organization.

Small organizations keep object management simple by having all other objects, such as users, printers, servers, etc., directly under the Organization object.

Organizations that are large enough to have departments or other organizational units usually decide to have their tree structure reflect their organizational structure.

As shown in this lab example, these organizations create Organizational Unit objects (specified using OU=name) that reflect their departments, divisions, geographical locations, etc., as is logical for their organization.

Sometimes large organizations create multiple Organization objects below the Tree object to represent separate business units or subsidiaries.

C Every tree requires an Admin User object. You will log in as admin to create or import other User objects and to create the rest of your tree structure.

D This example shows two Organizational Unit objects at the department level (LAB and IS).

E It also illustrates how Organizational Unit objects can be nested to provide as complex a hierarchy as is necessary to manage the organization.

Your Current Lab Tree

The eDirectory tree you have created by installing OES in your lab is illustrated and explained in [Figure 2](#). The objects that are grayed out are for explanation purposes and do not exist in your current tree. When you finish with this guide, your tree will look more like [Figure 1 on page 19](#).

Figure 2 Your Current Lab Tree

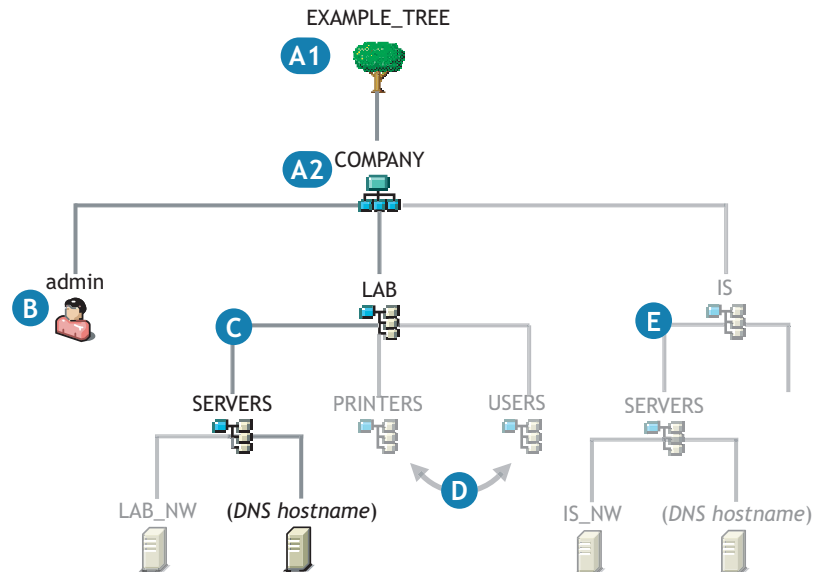

A The OES installation process requires that you specify names for the following objects:

- A1 A Tree object
- A2 An Organization object

B One of the first objects you specify during an initial installation is the Admin user.

During an initial installation, you should also specify this Admin for each parameter that calls for a User object (administrator, proxy user, etc.).

C The OES installation process can also create Organizational Unit objects to define a context for the OES Server object (DNS hostname).

D All other Organization Unit objects that you have planned for your tree must be created after the installation completes.

E The exception to this is that subsequent installations can create additional contexts (for example, IS > Servers) to contain other OES servers (for example, IS_NW) that you install into the tree.

Expanding Your Lab Tree

The instructions in this guide cover only the installation of a single OES server in the tree.

If you were to decide to install additional servers in the tree, the processes you would follow could involve some preparatory tasks as illustrated in [Figure 3](#).

Figure 3 An Expanded Tree

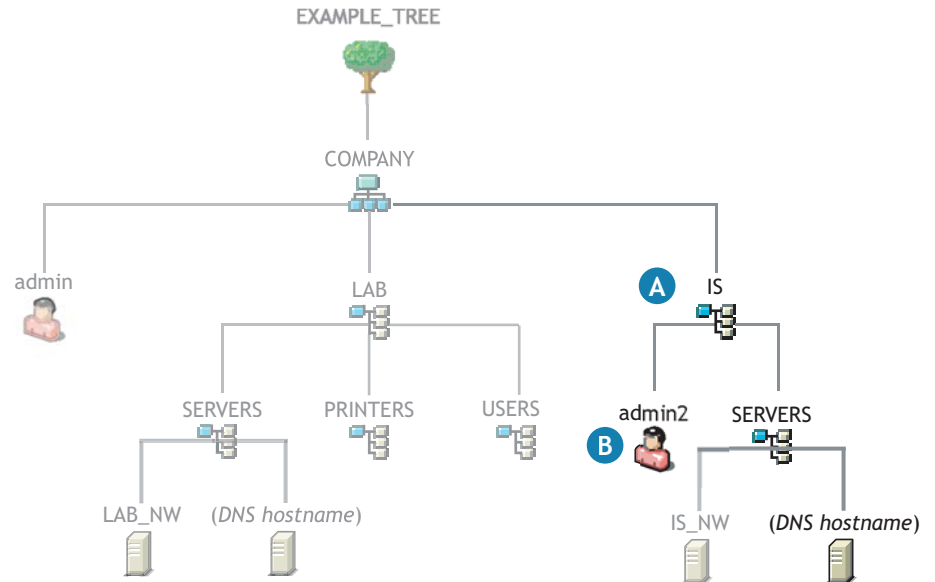

A During subsequent installations into the same tree, you can create new Organizational Unit objects to provide a context for other OES servers being installed.

B If you want to specify other Admin users in the OES installation parameters, you can do this during the installation.

Access iManager

Novell iManager is the main browser-based tool you will use to manage eDirectory and your OES services.

To start iManager and prepare your browser for future sessions:

- 1 In a browser, start iManager by entering the following URL:

`http://IP_or_DNS/nps/iManager`

where *IP_or_DNS* is the IP address or DNS name of your OES server.

If your server has a DNS name on your network, the OES installation will have used that name when creating the SSL certificate for the server. We recommend that you use that name in all OES access URLs.

- 2 (Conditional) If you do not receive a security alert (typically a pop-up message stating that the certificate is not trusted by your browser), skip to **“Create a Context for Your Users and Groups” on page 22**.

If you receive a security alert, it is because the eDirectory certificate authority (CA) that issued the certificate for your OES server is not recognized by your browser as a valid CA.

In this case, you have the following options:

- ♦ You can click Yes to proceed each time you receive an alert.

If you prefer this option, skip to **“Create a Context for Your Users and Groups” on page 22**.

- ◆ You can avoid future messages when using the browser by importing the CA's certificate (also called the root certificate).

If you want to do this, continue with [Step 3](#).

- ◆ You can purchase and install a server certificate from a third-party CA that the browser recognizes.

This process is beyond the scope of this guide. For more information, see the documentation for your Linux platform and [“Using Certificate Authorities from Third-Party Providers”](#) in the *Novell eDirectory 8.7.3 Administration Guide*.

- 3** In the Security Alert pop-up dialog box, click View Certificate.
- 4** Click Install Certificate > Next.
- 5** Select the Place All Certificates in the Following Store option.
- 6** Click Browse.
- 7** Select Trusted Root Certification Authorities.
- 8** Click OK > Next > Finish.
- 9** Confirm that you want to add the certificate to the root store.
- 10** Click OK > OK > Yes.



Do not close iManager. Continue with the next section, [Create a Context for Your Users and Groups](#).

Create a Context for Your Users and Groups

All OES products require that you create User objects to represent the users on your system. The Linux User Management and Samba components for OES Linux servers also require that you create a Group object that you can assign the users to.

If you reviewed [“An Introduction to eDirectory Planning” on page 18](#), you might have noticed an Organizational Unit object in [Figure 2](#) and [Figure 3](#) named Users. It is usually helpful to have at least one Organization Unit object to contain user-related objects, such as User objects and Group objects.

Create an Organizational Unit container object named Users in the lab Organizational Unit object by completing the following steps:

- 1** In iManager, click the View Objects icon .
- 2** In the left pane, click the Down-arrow  next to the COMPANY Organization object .
- 3** Click LAB, then select Create Object from the drop-down list.
- 4** From the Available Object Classes list, select Organizational Unit and then click OK.
- 5** In the Organizational Unit name field, type **USERS**.
- 6** Click OK > OK.

Do not close iManager. Continue with the next section, [Set Up Universal Password for Users](#).



Set Up Universal Password for Users

On networks where administrators plan to provide Samba access from Windows workstations to file services on an OES server, the simplest password management method is to establish a Universal Password policy for all eDirectory users. This ensures that passwords are always synchronized.

The OES for Linux installation creates a Universal Password (UP) policy named Samba Default Password Policy.

To ensure a consistent lab experience, you will associate the Samba policy with the USERS container created in [“Create a Context for Your Users and Groups” on page 22](#).

Complete the following steps:

- 1 In iManager, click the Roles and Tasks icon .
- 2 click Passwords > Password Policies.
- 3 Click Edit.
- 4 Click the Policy Assignment tab.
- 5 Click Browse icon  next to the Assign To field.
- 6 In the left pane, click the Down-arrows  next to COMPANY > LAB.
- 7 Select the USERS Organization Unit object > click OK.
- 8 Click Apply > OK.



Do not close iManager. Continue with the next section, [Create and Enable a Group Object for Linux User Management \(LUM\)](#).

Create and Enable a Group Object for Linux User Management (LUM)

If you want to have eDirectory users access PAM-enabled services such as login, passwd, etc., on an OES server or Linux workstation, you will need to enable the users for Linux User Management (LUM).

LUM is also required if you want Samba (Windows CIFS/SMB) file services available from the OES server available to eDirectory users.

The first step in the Linux or LUM enablement process is to create a group object to which the users will belong and enable that object for Linux User Management.

- 1 In the Roles and Tasks list, click Groups > Create Group.
- 2 In the Group Name field, type **LUMUsers**.
- 3 Click the Browse icon  next to the Context field.
- 4 Click the USERS object.
- 5 Click OK > OK.
- 6 Click the Browse icon  below Select the Linux Config Object.
- 7 In the Object Selector window, click the Up-arrow , then click the UNIX Config object.

This associates the LUMUsers group with all the OES Linux servers currently installed in the tree.

8 Click OK > OK.

You will associate the users that you create in the next section with this LUM-enabled group. They will then have access through eDirectory to the OES Linux servers currently installed in the tree.

Do not close iManager. Continue with the next section, [Create Users \(First Server in the Tree\)](#).



Create Users (First Server in the Tree)



NOTE: If you have already installed and worked with an OES NetWare server, the following three user objects already exist and only need to be enabled for Linux User Management. For instructions, skip to [“LUM-Enable Existing Users \(First OES Linux Server in the Tree\)” on page 25](#)

For the lab exercises, you will need to create the users shown in [Table 2](#).

Table 2 Users to Create

Field Name	User 1	User 2	User 3	Other Users
Username:	ajohns	bjohnson	cmartin	Some OES file services can be accessed from Windows without requiring a username and password if the eDirectory usernames and passwords match those used to log in to Windows. To prepare for testing these file services, create eDirectory users that match the Windows users you will use to log in to the Windows workstations in the lab. Alternatively, you can create Windows users that match the three eDirectory usernames listed in this table.
First name:	Arnold	Bobby	Chris	
Last name:	Johns	Johnson	Martin	



- 1** Continuing from [Step 8](#) in the previous section, in the left pane click Users > Create User.
- 2** In the Username field, type a username in [Table 2](#). (This is ajohns the first time through the process.)
- 3** Type the first name (optional) and last name (required) for the user as shown in [Table 2](#).
- 4** Click the Browse icon  next to the Context field.
- 5** Click the Down-arrow  next to the LAB object, then click the USERS object.
- 6** Type the same password in both the Password and Retype Password fields.
If the user you are creating is to match a Windows user as described in Other Users in [Table 2](#), be sure the password matches the password in Windows.
- 7** Do not check Set Simple Password.
This is not required for OES because Universal Password is used.
- 8** Do not check Create Home Directory.
This is a NetWare option only.

- 9** (Optional) If desired, type a Title and other information you want to appear in eGuide search results.
- 10** Click OK > OK.
- 11** Click the Browse icon  to locate a Primary Group for the user.
- 12** In the Object Selector window, click the Down-arrow  next to the USERS object.
- 13** Click LUMUsers.
- 14** Do not change the Samba settings.
- 15** Click OK > OK.
- 16** Repeat this process (taking into account that the navigation path to some objects has changed) for the other users listed in [Table 2](#) and for any additional User objects you want to create.

LUM-Enable Existing Users (First OES Linux Server in the Tree)

If you have already installed and worked with an OES NetWare server, the three user objects already exist, but they need to be enabled for Linux User Management.

Complete the following steps for all users you want to be able to use for the steps in this guide.

- 1** In the Roles and Tasks column click Linux User Management > Enable User for LUM.
- 2** Click the Browse icon  next to the Select a User field.
- 3** Click the Down-arrow  next to the USERS object, then click the user object you want to modify.
- 4** Click OK.
- 5** Click the Browse icon  to locate a Primary Group for the user.
- 6** In the Object Selector window, navigate to and select the LUMUsers object.
- 7** Do not change the Samba settings.
- 8** Click OK > OK.
- 9** Repeat this process (taking into account that the navigation path to some objects has changed) for the other users you want to enable for LUM and for any additional User objects you want to create.

A Note about Identity Manager Bundle Edition

If your organization has more than one directory storing user information, you should consider implementing Novell Identity Manager Bundle Edition included with Novell Open Enterprise Server.

The Identity Manager Bundle Edition provides licensed synchronization of information (including passwords) held in NT Domains, Active Directory Domains, and eDirectory trees.

Not only can you import User objects into eDirectory rather than creating them as you have in this section, but you can use Identity Manager to keep all the user data (including passwords) that are stored in your different databases synchronized with each other.

When data from one system changes, Identity Manager detects and propagates these changes to other connected systems based on the business policies you define.

For more information, see “Using the Identity Manager Bundle Edition” in the *Novell OES Planning and Implementation Guide*.

What's Next

When you have created all the User objects for your lab, continue with [Chapter 3, “Novell Samba \(Windows File Services\) on OES,”](#) on page 27.

3

Novell Samba (Windows File Services) on OES

Samba is an open-source, free software suite that lets you use the Microsoft* SMB/CIFS networking protocol with Linux* computers and other platforms. Samba lets Windows* users access the Novell® Open Enterprise Server (OES) like they would a Windows file server.

Samba is freely available under the GNU General Public License.

This section discusses the following:

- ◆ “Overview of Novell Samba” on page 27
- ◆ “Create Samba User Home Directories” on page 28
- ◆ “What’s Next” on page 29

Overview of Novell Samba

Figure 4 illustrates the file services that are enabled by completing the steps in “Create Samba User Home Directories” on page 28.

A more detailed overview of Samba file services on OES is found in “Novell Samba” in the *Novell OES Planning and Implementation Guide*.

Figure 4 Samba on OES

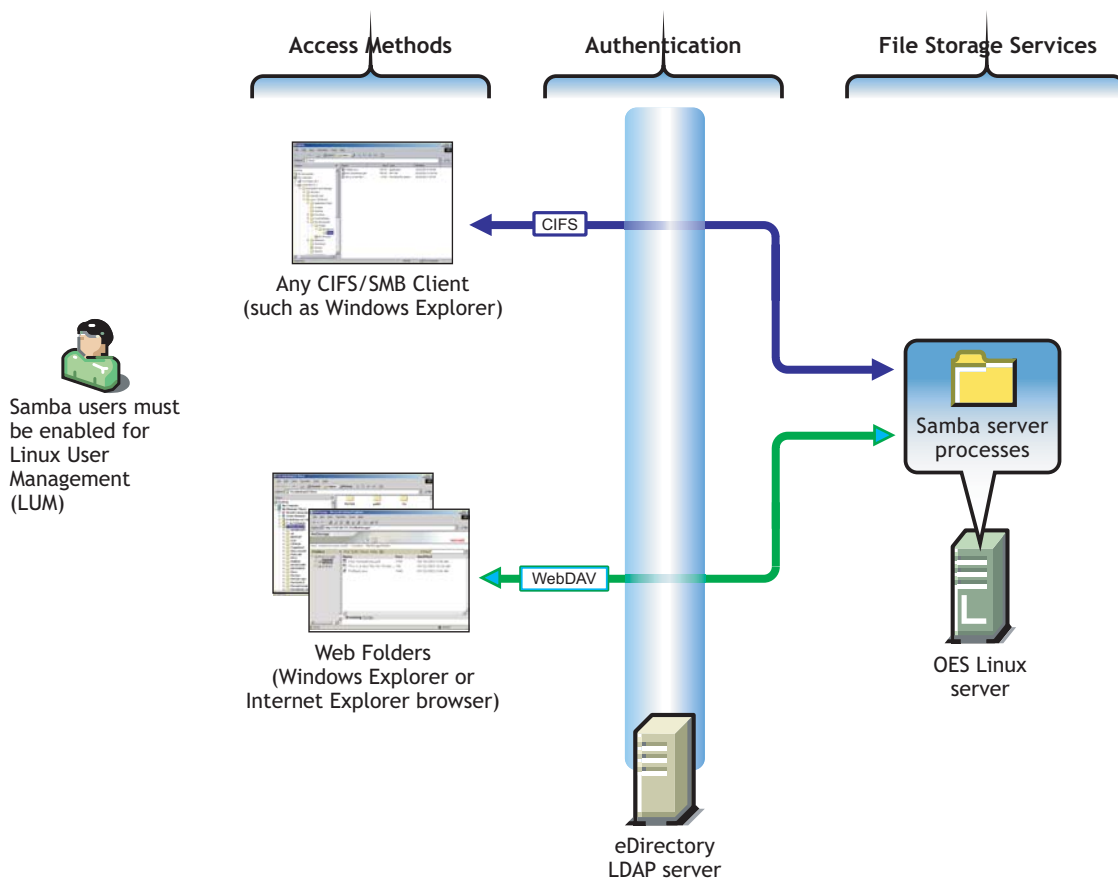

Create Samba User Home Directories

As you created User objects in “[Create Users \(First Server in the Tree\)](#)” on page 24, you were told not to change the Samba settings ([Step 14 on page 25](#)). If you followed this advice, the User objects you created are enabled for access to Samba on OES.

However, before users can access Samba, you must create user home directories by logging in as each user from a shell prompt on the Linux server.

- 1 While logged in as the root user, access a shell prompt on the OES server.

Many Linux administrators don’t load a graphical user interface (GUI) on their Linux servers and, therefore, always work through a shell prompt.

If you are running a GUI, you can access a shell prompt by pressing Ctrl+Alt+F1.

IMPORTANT: Do not attempt to complete this procedure from a shell prompt launched from within the GUI or from a remote session, such as an SSH session. If you do, the home directory creation process will fail.

- 2 Log in at the shell prompt by entering a username and password that you created in “[Create Users \(First Server in the Tree\)](#)” on page 24.

The system should report that a home directory has been created.

- 3 At the system prompt, enter **exit**.

- 4 Repeat [Step 2](#) and [Step 3](#) for each User object you want to give access to Samba services.

- 5** (Conditional) When you have finished creating home directories for all your Samba users, if you are running a GUI, you can press Ctrl+Alt+F7 to switch back to the GUI screen.

What's Next

If you want to test Samba file services at this point, go to [“Using Samba \(Windows File Services\)” on page 49](#).

Otherwise, continue with [Chapter 4, “Novell iFolder,” on page 31](#).

4

Novell iFolder

As a key file service component of Novell® Open Enterprise Server (OES), Novell iFolder® provides a Web- and network-based repository (iFolder server) that stores master copies of locally accessible files.

This section discusses the following:

- ♦ “Overview of iFolder” on page 31
- ♦ “Set Up User Search Contexts” on page 32
- ♦ “Enable iFolder Users” on page 33
- ♦ “What’s Next” on page 33

Overview of iFolder

Figure 5 illustrates the file services that are enabled by completing the steps in the sections that follow.

A more detailed overview of iFolder file services on OES is found in “iFolder 2.1x” in the *Novell OES Planning and Implementation Guide*.

Figure 5 iFolder File Services on OES

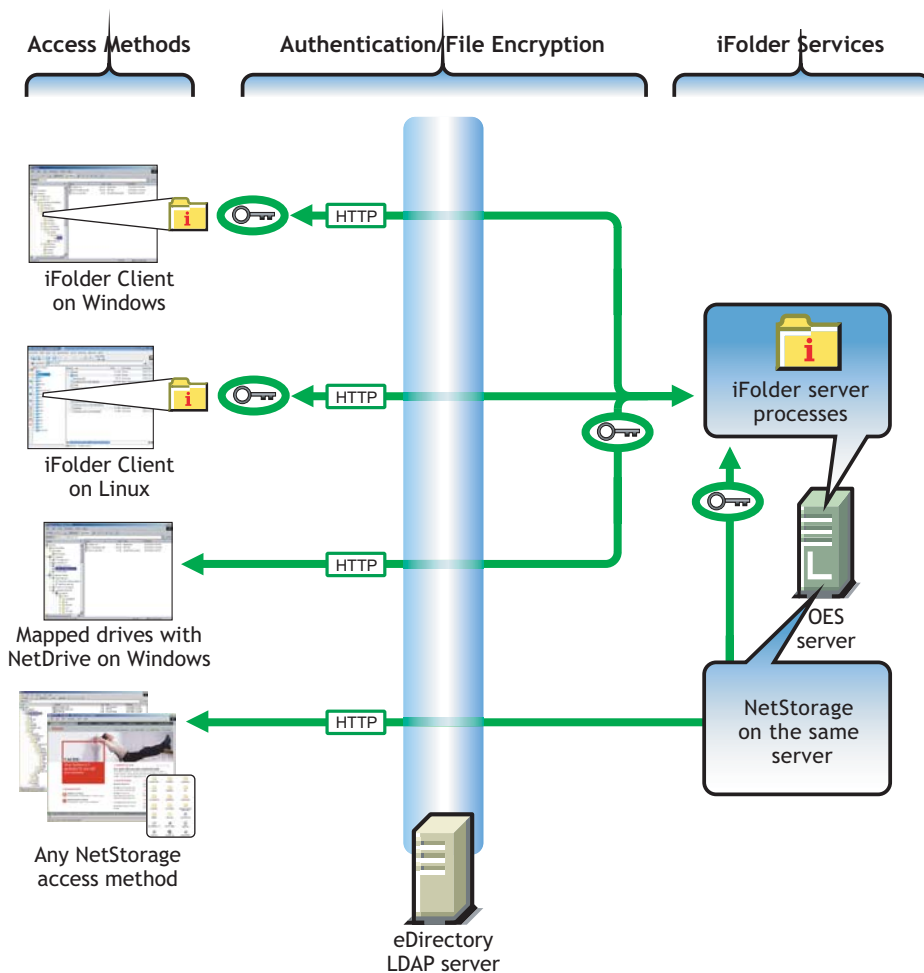

Set Up User Search Contexts

Do the following:

- 1 Start the iFolder Management tool by entering the following URL in a browser Address field:

`https://IP_or_DNS/iFolderServer/Admin`

where IP_or_DNS is the IP address or DNS name of your iFolder server process running on the OES Linux server.

IMPORTANT: This is the address and hostname you assigned during iFolder configuration, not the address used for the OES Linux server and other services.

If your server has a DNS name on your network, the OES installation will have used that name when creating the SSL certificate for the server. To avoid certificate mismatch messages, use the DNS name in all access URLs.

- 2 Click the Global Settings icon .
- 3 Log in as Admin.
- 4 In the left pane, click User LDAPs.
- 5 In the right pane, click the iFolder LDAP Server link.

- 6** In the Contexts to Search section, check the Search Subcontexts option.
- 7** Click Update.

Enable iFolder Users

The following steps should not be necessary for the lab installation because all users created after iFolder is installed are automatically enabled for iFolder. However, it is a good idea to confirm that network users are in fact enabled for iFolder access.

- 1** Continuing from **Step 7** in the previous section, click the User Management icon .
- 2** In the left pane, click Advanced Search.
- 3** In the right pane, click Search.

Notice that the users created since iFolder was installed are enabled for iFolder access .

- 4** (Optional) Use the options in the User Management dialog to enable additional users for iFolder.

What's Next

If you want to test iFolder file services at this point, go to [“Using iFolder” on page 50](#).

Otherwise, continue with [Chapter 5, “Virtual Office,” on page 35](#).

5

Virtual Office

As a key productivity component of Novell® Open Enterprise Server (OES), Novell Virtual Office provides Web access to OES services.

This section discusses the following:

- ♦ “[Overview of Virtual Office](#)” on page 35
- ♦ “[What’s Next](#)” on page 36

Overview of Virtual Office

[Figure 6](#) illustrates the services that are available by default on the lab installation of OES outlined in this guide.

A more detailed overview of Virtual Office on OES is found in “[Overview of Virtual Office](#)” in the *Novell OES Planning and Implementation Guide*.

Figure 6

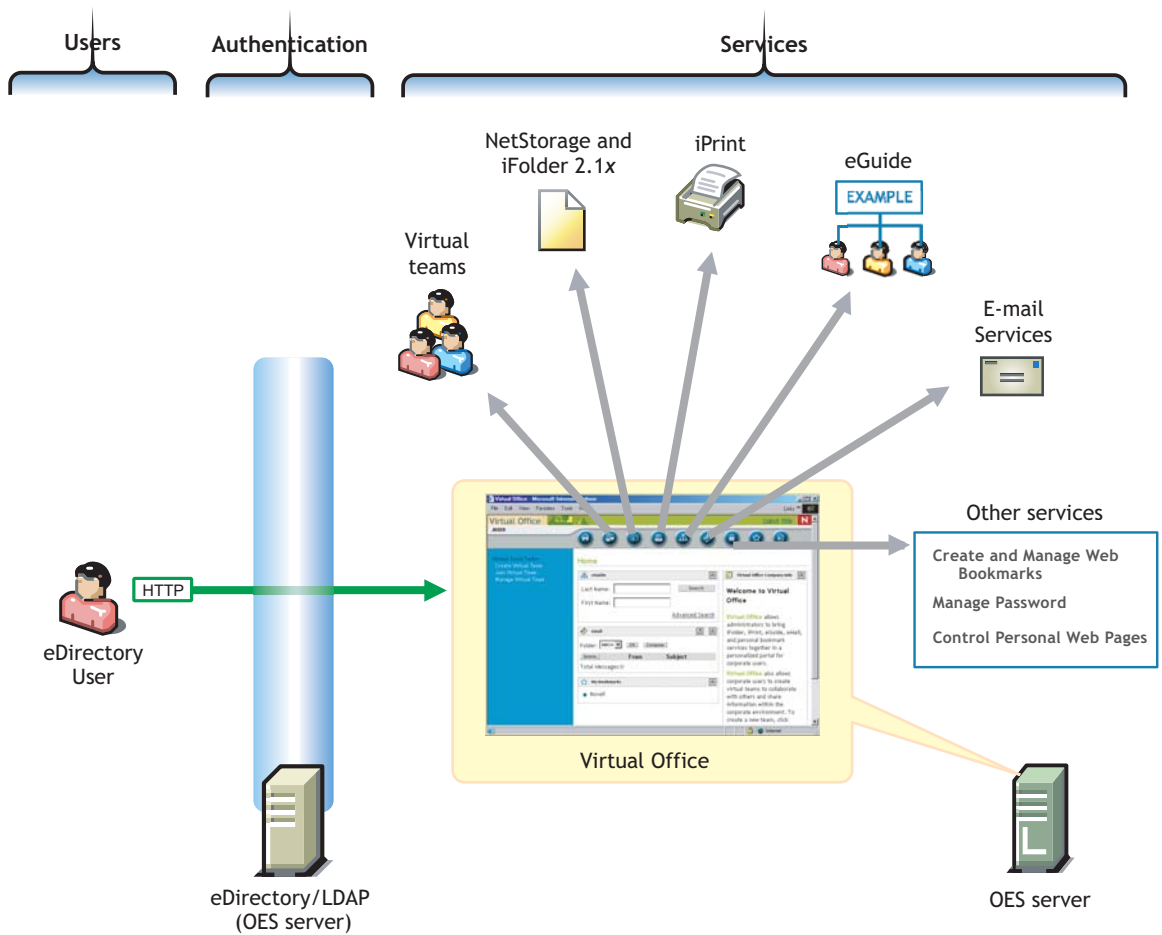

What's Next

When you completed the instructions in [Chapter 1, "Installing an OES Linux Server in Your Lab,"](#) on [page 9](#), your Virtual Office installation was complete. No further configuration is required.

If you want to test Virtual Office at this point, go to ["Using Virtual Office"](#) on [page 51](#).

Otherwise, continue with [Chapter 6, "iPrint,"](#) on [page 37](#).

6 iPrint

As the print services component of Novell® Open Enterprise Server (OES), Novell iPrint provides a powerful and easy-to-implement printing solution that lets your network users print from any Windows* workstation to any network printer. iPrint provides the print services behind the Print button in Virtual Office.

This section discusses the following:

- ◆ “Overview of iPrint” on page 37
- ◆ “Create an eDirectory Context for Printers” on page 38
- ◆ “Create a Print Driver Store” on page 39
- ◆ “Add Printer Drivers to the Driver Store from the Windows Platforms” on page 39
- ◆ “Create a Print Manager Object” on page 40
- ◆ “Create iPrint Printer Objects” on page 40
- ◆ “What’s Next” on page 41

Overview of iPrint

Figure 7 on page 38 illustrates the printing services that are enabled by completing the steps in the sections that follow.

A more detailed overview of iPrint services on OES is found in “iPrint Functionality” in the *Novell OES Planning and Implementation Guide*.

Figure 7 iPrint on OES

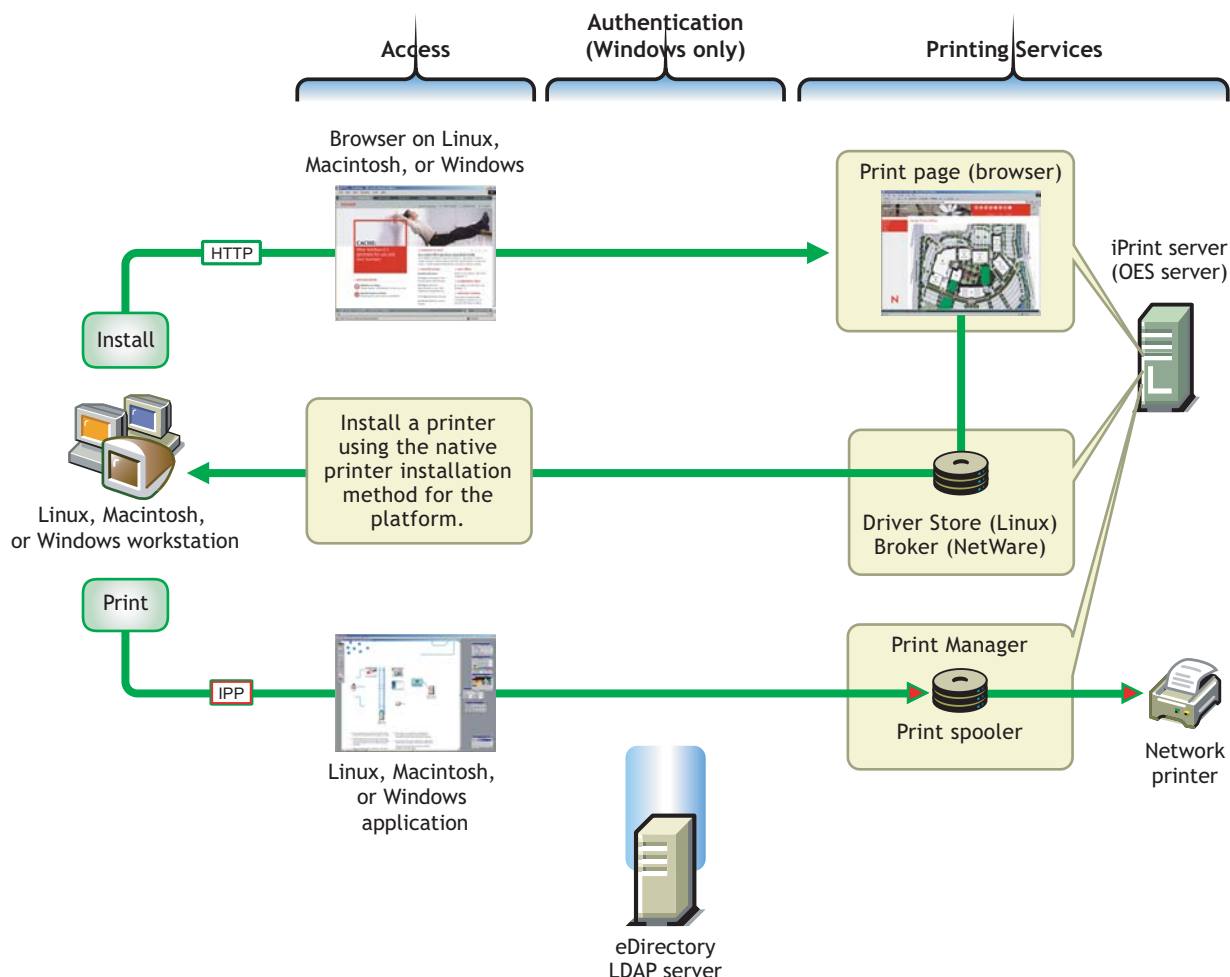



Create an eDirectory Context for Printers

System administrators often create one or more container objects just for network printers. Obviously, this is an optional organizational preference issue. The printers themselves can be placed in the most convenient places for your network users.

- 1 Start iManager by entering the following URL in a browser Address field:







http://IP_or_DNS/nps/iManager

where *IP_or_DNS* is the IP address or DNS name of your OES server.

- 2 Log in to iManager as Admin.
- 3 Click the View Objects icon .
- 4 In the left pane, click the Down-arrow  next to the COMPANY Organization object.
- 5 Click lab, then select Create Object from the drop-down list.
- 6 From the Available Object Classes list, select Organizational Unit and then click OK.
- 7 In the Organizational Unit Name field, type **PRINTERS**.
- 8 Click OK > OK.

Create a Print Driver Store

iPrint stores print driver files by workstation type for each of your network printers in a driver store in eDirectory.

- 1 In iManager, click the Roles and Tasks icon .
- 2 Click iPrint > Create Driver Store.
- 3 In the Driver Store Name field, type **Print_Drivers**.
- 4 Click the Browse icon  next to the Container Name field.
- 5 Click the Down-arrow  next to LAB, then click the PRINTERS Organizational Unit object.
- 6 Click the Browse icon  next to the eDir Server field.
- 7 Click the Down-arrow  next to LAB, click the Down-arrow  next to SERVERS, then click your OES server name.
- 8 Click OK > OK.

Add Printer Drivers to the Driver Store from the Windows Platforms

You can load printer drivers to the Driver Store using driver files. However, because most Windows workstations have an extensive list of printer drivers available on the system, the simplest way to add drivers is to load them directly from a workstation.

In other words, you can load the Windows XP drivers from a Windows XP workstation, Windows 2000 drivers from a Windows 2000 workstation, etc.









Complete the following steps once for each of the following Windows platforms that you have in your lab:

- ♦ Windows XP
 - ♦ Windows 2000
 - ♦ Windows NT 4
 - ♦ Windows 95/98/ME
- 1 Open a browser on the workstation and enter the following URL in the Address field:
`http://IP_or_DNS/ipp`
where *IP_or_DNS* is the IP address or DNS name of your OES server.
 - 2 Click Install iPrint Client.
 - 3 Click Open.
 - 4 Read the license agreement, then click I Agree.
 - 5 After the client installs, click Finish.
 - 6 Close the browser.
 - 7 If it is not already running, start iManager (<http://server/nps/iManager>) and log in as Admin.
 - 8 Click iPrint > Manage Driver Store.
 - 9 Click the Browse icon  next to the iPrint Driver Store Name field.

- 10** Browse to the Printers container (example > lab > printers), then click the Print_Drivers object.
- 11** Click OK.
- 12** Click the Drivers tab.
- 13** Click the link for your workstation type (Windows XP, Windows 2000, etc.).
- 14** Click Add from System.
- 15** In the Add Resource dialog box, select the correct driver for the printer you plan to use for the lab test.
- 16** Click OK.
- 17** (Optional) To test multiple printers, repeat **Step 14** through **Step 16** for each printer you want to test.
- 18** When finished, click Apply > OK.

Create a Print Manager Object





The iPrint Manager is represented by and managed through a Print Manager object in eDirectory™. It is a daemon that runs on the OES server, and it must be running when you create Print objects. After printing is set up, the iPrint Manager receives print job requests and forwards them to printers when the printers are ready.

- 1** Continuing from **Step 18** in the previous section, click iPrint > Create Print Manager.
- 2** In the Manager Name field, type the following:
iPrint_Manager
- 3** Click the Browse icon  next to the Container Name field.
- 4** Click the Down-arrow  next to LAB, then click PRINTERS.
- 5** Click the Browse icon  next to the eDir Server field.
- 6** Click the Down-arrow  next to LAB, click the Down-arrow  next to SERVERS, then click your OES server name.
- 7** Click the Browse icon  next to the Driver Store field.
- 8** Click the Down-arrow  next to LAB, click the Down-arrow  next to PRINTERS, then click Print_Drivers.
- 9** In one of the iPrint Service fields, type either the full DNS name of this server or its IP address, depending on the option you select.
- 10** Click OK > OK.

Create iPrint Printer Objects

You can create iPrint Printer objects for all your printers that have drivers in the Driver Store and an IP address or DNS name.

- 1** In iManager, click the Roles and Tasks icon .
- 2** Click iPrint > Create Printer.
- 3** In the Printer Name field, type a name for your printer.

- 4** Click the Browse icon  next to the Container Name field.
- 5** Click the Down-arrow  next to LAB, then click PRINTERS.
- 6** Click the Browse icon  next to the Print Manager Name field.
- 7** Click the Down-arrow  next to LAB, click the Down-arrow  next to PRINTERS, then click iPrint_Manager.
- 8** Type the DNS name or IP address of the printer in the field indicated.
- 9** Type a location so users will know where to find the printer.
- 10** (Optional) Type a description.
- 11** Click Next.
- 12** Select the appropriate drivers for each Windows platform you are testing.
- 13** Click Next.
- 14** Click OK.

What's Next

If you want to test iPrint at this point, go to [“Using iPrint” on page 51](#).
Otherwise, continue with [Chapter 7, “NetStorage,” on page 43](#).

7

NetStorage

As a versatile file services component of Novell® Open Enterprise Server (OES), Novell NetStorage provides the file services behind the Files button in Virtual Office. NetStorage can also be accessed directly rather than through Virtual Office.

This section discusses the following:

- ♦ “Overview of NetStorage” on page 43
- ♦ “What’s Next” on page 44

Overview of NetStorage

Figure 8 illustrates the NetStorage file services that are enabled by default.

A more detailed overview of NetStorage file services on OES is found in “NetStorage” in the *Novell OES Planning and Implementation Guide*.

Figure 8 NetStorage on OES

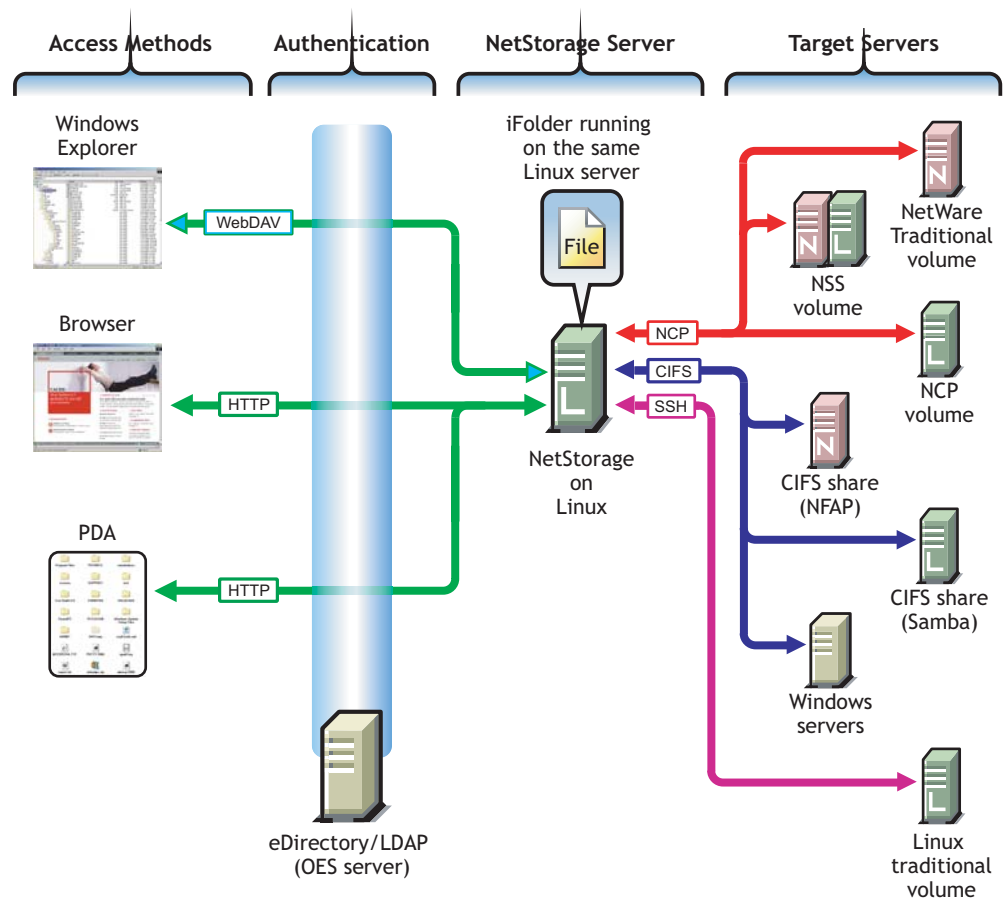

In OES, the default NetStorage installation provides access to two folders:

- ◆ A shared folder on the local file system that contains a ReadMe.html file with instructions for creating NetStorage Storage Location objects.
- ◆ An iFolder Storage Provider link to the Novell iFolder[®] data store on the server.

In OES, access to iFolder through NetStorage is automatically configured.

What's Next

If you have already tested iFolder (see the Important note above) and you want to test NetStorage file services at this point, go to [“Using NetStorage” on page 52](#).

Otherwise, continue with [Chapter 8, “eGuide,” on page 45](#).

8

eGuide

Novell® eGuide provides user access to information stored in eDirectory™ and other LDAP-compliant data sources. eGuide provides “white pages” access to user information through the eGuide button in Virtual Office.

Depending on how you configure eGuide, any information you choose to store in eDirectory objects can be exposed to users.

This section discusses the following:

- ◆ “Overview of eGuide” on page 45
- ◆ “What’s Next” on page 46

Overview of eGuide

Figure 9 on page 46 illustrates that by default eGuide on OES lets users view their own information and see limited information about other users on the system.

A more detailed overview of eGuide on OES is found in “White Pages (eGuide)” in the *Novell OES Planning and Implementation Guide*.

Figure 9 eGuide on OES

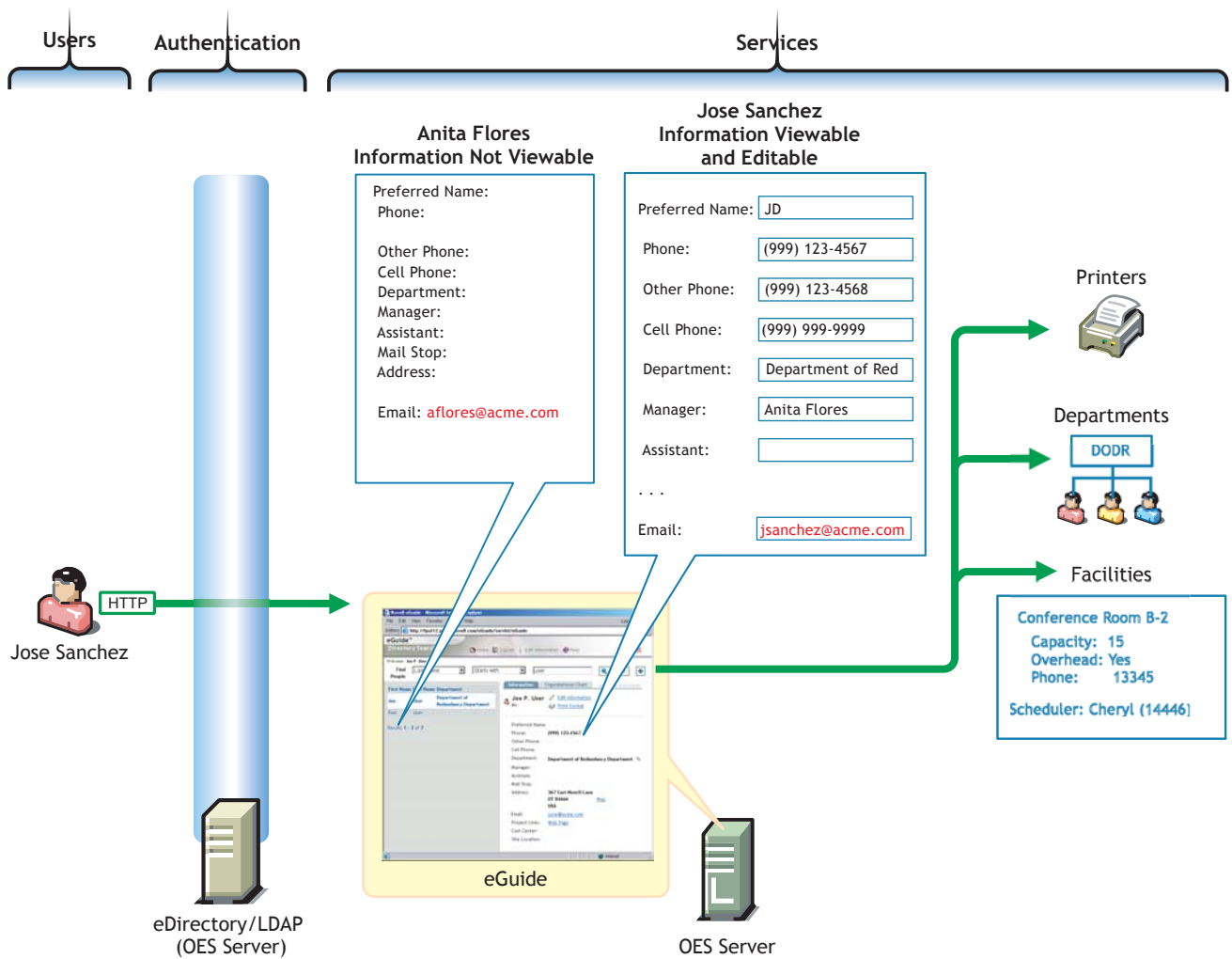

What's Next

If you want to test eGuide at this point, go to [“Using eGuide” on page 52](#).

Otherwise, continue with [Chapter 9, “Linux User Management,” on page 47](#).

9

Linux User Management

Novell® Linux User Management (LUM) is a key component of Novell Open Enterprise Server (OES) and provides two basic functions:

- ♦ It lets you create Linux* User objects in eDirectory™ for Windows* users who will access Samba file services on your OES server, as demonstrated earlier in this guide.
- ♦ It lets you require users who are accessing PAM-enabled services, such as login or ftp, on the OES server to authenticate through eDirectory.

This section discusses the following:

- ♦ “[Overview of Linux User Management](#)” on page 47
- ♦ “[What’s New](#)” on page 48

Overview of Linux User Management

Figure 10 illustrates how LUM works with PAM-enabled services. For a more detailed overview, see “[Linux User Management](#)” in the *Novell OES Planning and Implementation Guide*.

Figure 10 Linux User Management on OES

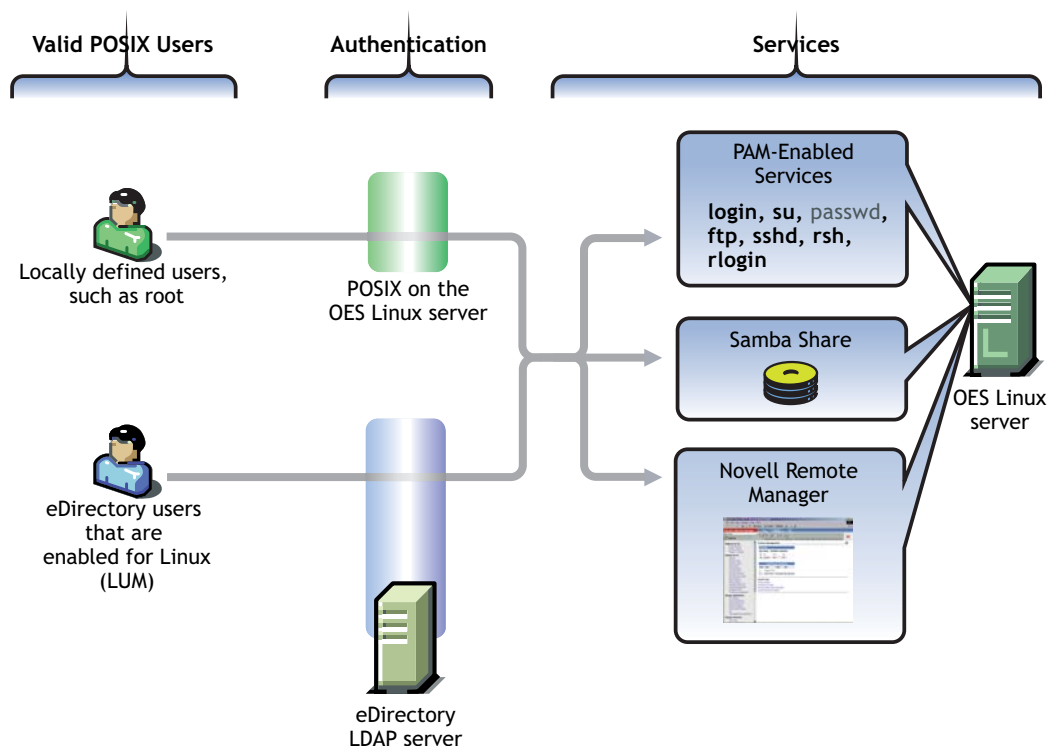

Table 3 on page 48 shows the OES and PAM-enabled services that can be controlled by having LUM installed.

Table 3 PAM-enabled Services

Command	Where Executed	Function for LUM Users
ftp	Another host	Transfer files to and from the OES server after supplying an eDirectory/LUM username and password.
login	OES server or in an SSH session with the OES server	Log in to the OES server using an eDirectory/LUM username and password, either directly or in an SSH session with the server if sshd is also enabled.
passwd	OES server or in an SSH session with the OES server	This command is not PAM-enabled by default, meaning that it will not use LUM. eDirectory users manage their passwords through eDirectory, not on the server. NOTE: For more information, see “ Password Support in OES ” in the <i>Novell OES Planning and Implementation Guide</i> .
rlogin	Another host	Log in to the OES server from a remote host system shell prompt after supplying an eDirectory/LUM username and password.
rsh	Another host	Execute a command on the OES server from a remote host system shell prompt after supplying an eDirectory/LUM username and password.
sshd	Another host	Establish a secure encrypted connection with the OES server after supplying an eDirectory/LUM username and password.
su	OES server or in an SSH session with the OES server	While logged in as an eDirectory/LUM user, temporarily become another user. This is most often used to temporarily become the root user (who is purposely not a LUM user) to administer the local Linux machine with full system privileges.

The user-creation steps you completed earlier in this guide (“[Create Users \(First Server in the Tree\)](#)” on page 24) created three LUM users with rights to log in to the OES server.

What’s New

If you want to test LUM services at this point, go to “[Using Linux User Management \(LUM\)](#)” on page 52.

Otherwise, continue with [Chapter 10, “Getting Acquainted with OES,”](#) on page 49.

10 Getting Acquainted with OES

After you have installed Novell® Open Enterprise Server (OES) and completed the configuration instructions located in the preceding sections, your OES server is ready for lab use.

The instructions and information in this section will acquaint you with the basic services available in OES. More detailed service overviews are available in the *Novell OES Planning and Implementation Guide*. For comprehensive documentation for each service, see the administration guides and other documentation listed on the [OES documentation Web site \(http://www.novell.com/documentation/oes\)](http://www.novell.com/documentation/oes).

This section guides you through the following tasks:

- ◆ “Using Samba (Windows File Services)” on page 49
- ◆ “Using iFolder” on page 50
- ◆ “Using Virtual Office” on page 51
- ◆ “Using iPrint” on page 51
- ◆ “Using NetStorage” on page 52
- ◆ “Using eGuide” on page 52
- ◆ “Using Linux User Management (LUM)” on page 52
- ◆ “What’s Next” on page 53

Using Samba (Windows File Services)

NOTE: To perform the steps in this section, you must have completed all the instructions in [Chapter 3, “Novell Samba \(Windows File Services\) on OES,” on page 27](#).

- 1** In Windows* Explorer, click Tools > Map Network Drive.
- 2** In the Folder field, type the following:

```
\\IP_or_DNS\username
```

where *IP_or_DNS* is the IP address or full DNS name of the OES server, and *username* is the login name of the Samba user.
- 3** (Conditional) If the Samba username and password don’t match the username and password that you used to log in to the Windows workstation, click the Different Username link and specify the username and password of a Samba user you created in eDirectory™.
- 4** Click Finish.
- 5** Drag some files from Windows Explorer or the desktop into the Samba folder.
- 6** At the OES server shell prompt as the root user, access the `/home/username` directory and verify that the files you placed in the Samba folder appear on the server.

By default, this drive mapping will be available each time the user logs in to the Windows workstation.

Using iFolder

NOTE: To perform the steps in this section, you must have completed all the instructions in [Chapter 4, “Novell iFolder,” on page 31](#).

Access User Accounts Using the iFolder Client

The steps in this section are required to activate an important feature of Novell iFolder®: encryption of user data in the iFolder data store.

Data encryption is automatically set up when users access their accounts for the first time through the iFolder client or using Novell NetDrive.

- 1 From a browser on a Windows workstation, access the iFolder server using the following URL:

```
http://IP_or_DNS/iFolder
```

where IP_or_DNS is the IP address or DNS name of your iFolder server process running on the OES Linux server.

IMPORTANT: This is the address and hostname you assigned during iFolder configuration, not the address used for the OES Linux server and other services.

- 2 In the left pane, click the Download Windows Client link.
- 3 In the Download dialog box, click Run > Run.
- 4 Click Next > Next.
- 5 Read the license agreement, then close the license window.
- 6 Click Yes to accept the license terms.
- 7 (Optional) Specify an alternate location for the program files.
- 8 Click Next.
- 9 Click Finish.
- 10 (Optional) Read the iFolder Readme file, then close the Readme window.
- 11 Click Finish to restart the computer.
- 12 After the computer restarts, read the information about using iFolder.
- 13 Click Continue.
- 14 Log in to iFolder using the username and password of the iFolder user who will use the workstation.
- 15 Accept the default iFolder location on the workstation or use the Browse button to specify an alternate location.
- 16 Click OK.
- 17 Leave the Encrypt Files option checked, then click OK.
- 18 Type a passphrase, a confirmation passphrase, and a hint (optional) in the fields provided, and then click OK.

19 Click OK to enable passphrase recovery.

Continue with the next section, “[Observing File Synchronization](#).”

Observing File Synchronization

To understand more about how iFolder works, it is helpful to observe the file synchronization processes in action.

- 1** Open the iFolder shortcut on your desktop.
- 2** Double-click the iFolder icon in your system tray, then click View Activity.
- 3** Create one or two test files on your desktop.
- 4** Drag the files to the iFolder Home folder.
- 5** In the View Activity window, observe that the files are copied to the iFolder server.
- 6** Delete a file or drag it back to the desktop and observe how the action is synchronized with the server.

Keep one or two files in the iFolder Home folder and continue with the next section, “[Using Virtual Office](#).”

Using Virtual Office

- 1** Using a Java-enabled Web browser, enter the following URL in the Address field:

`http://IP_or_DNS/vo`

where *IP_or_DNS* is the IP address or DNS name of your OES server.

- 2** Log in with the username you used in the “[Using iFolder](#)” section.
- 3** In the eGuide section, type **john** in the Last Name field and then click Search.
Both Arnold Johns and Bobby Johnson are listed.
- 4** Move the mouse over each of the icons at the top of the page and notice the label for each icon.

The following sections can be accessed using their own URLs, but for demonstration purposes we will have you access them through Virtual Office.

Using iPrint

NOTE: To perform the steps in this section, you must have completed all the instructions in [Chapter 6, “iPrint,” on page 37](#).

- 1** In Virtual Office, click the iPrint icon .
iPrint is installed as part of Virtual Office.
- 2** (Optional) If you have not already installed the iPrint client on this workstation, click the Install iPrint Client link and install the client.
- 3** After the client is installed, click the link to install a printer you created in “[Create iPrint Printer Objects](#)” on page 40.
You might have to click the Refresh button to see the printers.
- 4** Answer the prompts to install the printer on the workstation.

- 5 Access the Printers property page by clicking Start > Settings > Printers.
- 6 Right-click the printer, then click Properties.
- 7 Click Print Test Page.

Using NetStorage

NOTE: To perform the steps in this section, you must have completed all the instructions in [Chapter 4, “Novell iFolder,” on page 31](#) and in [“Using iFolder” on page 50](#).

- 1 In Virtual Office, click the Files icon .
- 2 In the left pane, click the iFolder folder.
- 3 Enter and confirm the passphrase.
- 4 Click Set Passphrase.
- 5 Click the iFolder folder again.

Notice that the files you previously worked with in the iFolder section appear in the right pane.

If you were to change folder contents as you did earlier, you would see the same coordination through the iFolder client as you did then. All changes to the iFolder data on the server are reflected to locally stored directories and files through the client.

- 6 To read more information about using NetStorage to access other file storage systems, click the Shared folder and double-click the Read Me.html file.

For more information on using NetStorage, see the [OES NetStorage Administration Guide for NetWare](#).

Using eGuide

- 1 In Virtual Office, click the eGuide icon .
- 2 Enter various search strings to display the eDirectory users you have created.

Notice that when you select the currently logged-in user, an Edit Information option is included.

Although this option appears, if users try to edit their information, the change will fail to save. To enable this feature, you must assign Role Based Services or ACLs. For more information, see the [Novell eGuide 2.1.3 Administration Guide](#).

Using Linux User Management (LUM)

The following steps briefly demonstrate how LUM works with PAM-enabled services.

- 1 At a the OES server, open a new shell prompt by pressing Ctrl+Alt+Fx, where Fx is the function key (F1 through F6) for an unused shell prompt.
- 2 Log in as the eDirectory user ajohns.
The command prompt changes, indicating you are logged in.
- 3 Open a different shell prompt using a different function key, such as F2.
- 4 Log in as the root user.

- 5** Change to the `/etc/pam.d` directory by entering

```
cd /etc/pam.d
```
- 6** Make a copy of the login file located in the directory by entering

```
cp login login.copy
```
- 7** Open the original login file for editing by entering

```
vi login
```
- 8** To enter Insert mode, type

```
i
```
- 9** Use the Delete and the Down-arrow keys to remove the first five lines of the file, so that the first line reads

```
##PAM-1.0
```
- 10** Press Escape.
- 11** Press and hold the Shift key, then press z twice.
- 12** Return to the first shell prompt and log out as user ajohns by entering

```
exit
```
- 13** Try to log in again as user ajohns.

The systems responds that the login request was incorrect.

When you removed the first five lines from the login file, you removed the LUM support from the login command.
- 14** To restore the LUM support for the login command, change to the shell prompt where you are logged in as the root user, then enter

```
rm login
```

to delete the file you changed in [Step 9](#) and

```
y
```

to confirm file deletion and

```
mv login.copy login
```

to rename the copy file created in [Step 6](#) to the original filename, restoring the original login behavior.
- 15** Change back to the first shell prompt and log in as ajohns to verify that LUM support is restored.

What's Next

After you complete the exercises in this guide, we recommend you do the following:

1. Think about the needs of your organization and how the various OES product components can help you address those needs.
2. Go back to the various components and work with them considering the needs you identified.
3. Begin planning your organization's eDirectory tree and the rollout of OES services to your organization.

As you plan for, work with, and install OES, you should consult the other OES product documentation:

Title	Contents
<i>Novell OES Planning and Implementation Guide</i>	Detailed overviews of all components, planning information and instructions, and links to configuration and maintenance information in the administration guides associated with each OES product component.
<i>OES for Linux Installation Guide</i>	Comprehensive installation instructions for all OES components.